

Polaroid MP-4
Land camera
Assembly and use

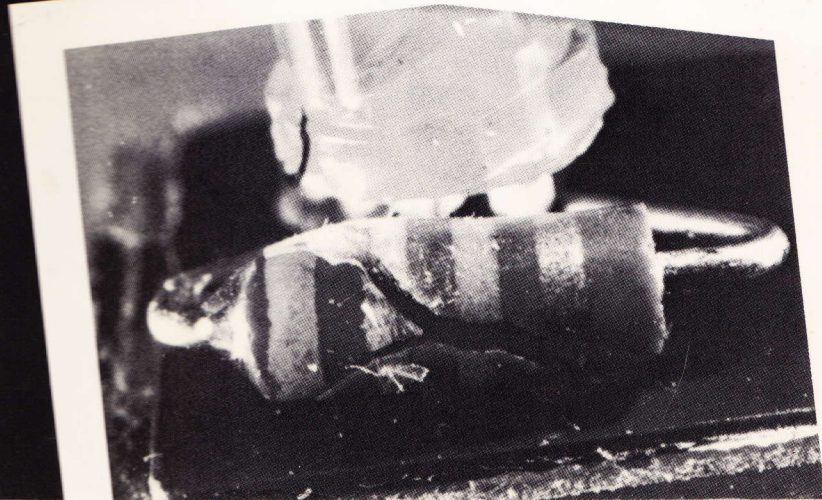
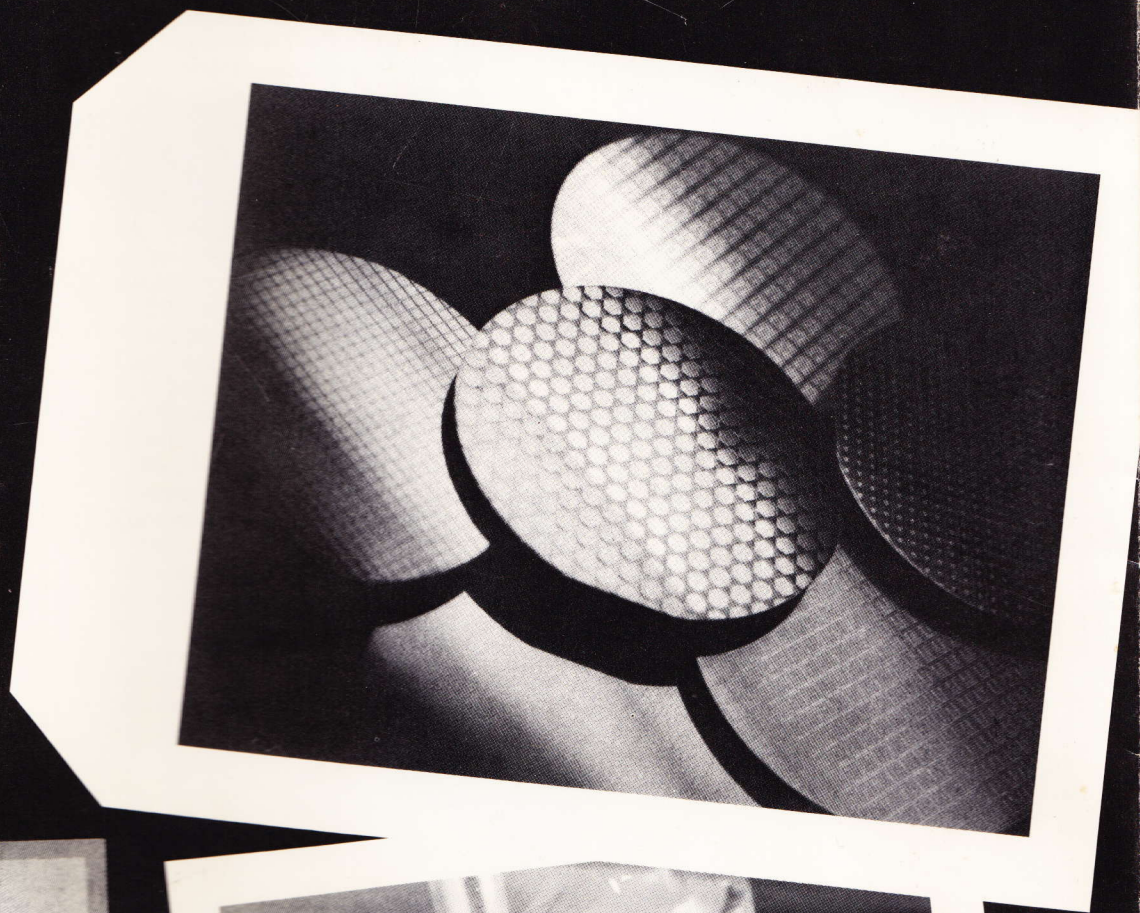

This product has been approved by Underwriters Laboratories, Inc. (UL). As a condition of approval UL requires that the following safety information be provided.

IMPORTANT SAFEGUARDS

AS WITH ANY ELECTRICALLY OPERATED EQUIPMENT, BASIC SAFETY PRECAUTIONS SHOULD BE OBSERVED. REMEMBER:

1. FOLLOW ALL INSTRUCTIONS.
2. DO NOT LEAVE UNIT UNATTENDED.
3. IF UNIT WILL NOT BE USED FOR EXTENDED PERIOD OF TIME, UNPLUG FROM ELECTRICAL OUTLET. GRASP PLUG, **NOT CORD**, AND PULL TO DISCONNECT FROM OUTLET.
4. DO NOT OPERATE UNIT WITH DAMAGED CORD, OR UNIT WHICH HAS BEEN DROPPED OR DAMAGED, UNTIL IT HAS BEEN EXAMINED BY AUTHORIZED SERVICE CENTER.
5. DO NOT LET POWER CORD HANG OVER FRONT EDGE OF TABLE OR COUNTER OR TOUCH HOT SURFACES.
6. UNIT MUST BE GROUNDED. POWER CORD HAS THREE-PRONGED GROUNDING PLUG, WHICH MUST BE PLUGGED INTO APPROPRIATE OUTLET. IF SUCH AN OUTLET IS NOT ALREADY AVAILABLE, EXISTING OUTLET MUST BE CHANGED. **DO NOT, UNDER ANY CIRCUMSTANCES, REMOVE GROUND PRONG FROM PLUG***.
7. IF EXTENSION CORD IS NEEDED, USE CORD WITH GROUNDING PLUG* AND SUITABLE CURRENT RATING. CORDS RATED FOR LOWER AMPERAGE THAN UNIT MAY OVERHEAT. ARRANGE CORD SO THAT IT WILL NOT BE TRIPPED OVER OR PULLED.
8. THE LAMPS GET HOT. DO NOT TOUCH THEM OR PLACE THEM EXCESSIVELY CLOSE TO CAMERA BELLOWS, DRAPES OR CLOTHING.
9. BEFORE STORING, ALLOW LAMPS TO COOL COMPLETELY. DISCONNECT POWER CORD AND LOOP IT LOOSELY AROUND CAMERA COLUMN.
10. TO AVOID ELECTRICAL SHOCK HAZARDS, DO NOT ATTEMPT TO OPEN SWITCH UNIT OR OUTLET UNITS, AND DO NOT IMMERSE THEM IN WATER OR OTHER FLUIDS. DO NOT OPERATE UNIT NEAR WATER OR WITH WET HANDS. IF SERVICE OR REPAIR WORK IS REQUIRED, CONTACT AUTHORIZED SERVICE CENTER.

*THIS APPLIES ONLY IN COUNTRIES WITH GROUNDED ELECTRICAL SUPPLIES.

PLEASE KEEP THESE INSTRUCTIONS

Contents

Camera parts	4
The two MP-4 models	5
The camera heads	6
The MP-4 shutter	7
Lenses for the MP-4	7
The focusing screens	7
The reflex viewer and hood	8
The interchangeable film holders	8
How to attach the electrical assembly	9
Attach camera column to baseboard	10
Camera assembly	11
Assembly and use of the sliding camera head	14
Assembly and use of the 44-40 fixed camera head	16
Assembly and use of the 44-44 fixed camera head	18
Assembly of lighting system	20
Camera operation	23
How to insert the Polaroid Land Film Holders	26
How to use the Polaroid Land Pack Film Holder 44-48	28
Camera tilt	31
Camera column rotation on MP-4 Model XLR	32
Camera body removal	33
MP-4 shutter accessories	33
Some other useful camera accessories	34
Filters for the MP-4	35
MP-4 care and maintenance	36
Warranty; Registration; Servicing	36
Polaroid Service Centers and Offices	37

Introduction

The Polaroid MP-4 Land Camera is an unusually versatile photographic unit. Its uses in industry, business, medicine, research, education, the graphic arts, and in a vast variety of other fields are almost unlimited. They include photomicrography, photomacrography, wall chart copying, slide making, X-ray copying, small object photography, gross specimen photography, and many others.

The camera can be used with almost all Polaroid Land film types. With these, it can complete most jobs within seconds, without a darkroom. The camera can also be used with wet-process films of some formats.

The selection of lenses, and a special macro extension, render possible a wide range of reproduction ratios, from extreme reduction to high magnification. For even higher magnification, the camera can be used together with a microscope.

With its wide selection of accessories, the MP-4 is much more than just a camera — it is a complete photographic system.

The versatility of the system is truly limited only by the imagination and ingenuity of the user.

Free and rapid technical assistance

If you ever need additional help in the use of your MP-4 camera, or advice on any other photographic problem, you may call us free of charge, Mon.-Fri., 9 a.m. to 6 p.m. (Eastern Time). From anywhere in the continental U.S.A., call **toll-free** at 800-225-1618. Or, write to Technical Assistance, Polaroid Corporation, 784 Memorial Drive 3M, Cambridge, Mass. 02139. For assistance in other countries, please contact the Polaroid office nearest you (see page 37 for list of addresses).

Camera parts

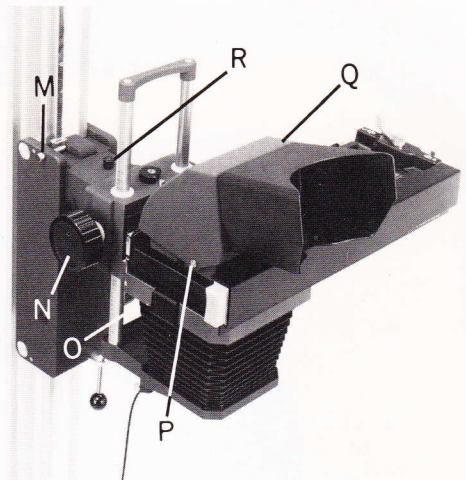
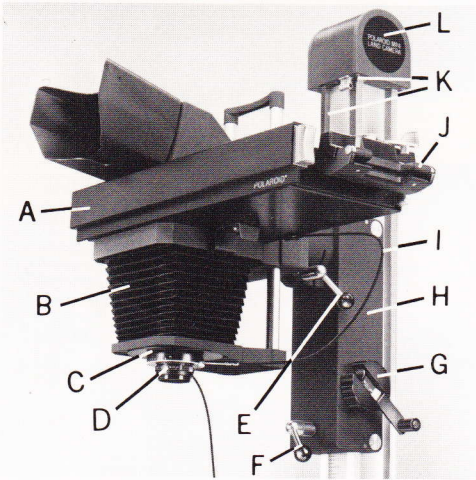

- A. Sliding camera head
- B. Camera body
- C. Shutter
- D. Lens
- E. Camera body locking knob
- F. Vertical carriage locking lever
- G. Height adjustment wheel and lever
- H. Vertical carriage
- I. "Pre-view" cable release
- J. Film holder
- K. Counterweight springs
- L. Counterweight spring box
- M. Spring attachment rod

- N. Focusing knob
- O. Millimeter scale (focusing column)
- P. Ground glass
- Q. Reflex viewer and hood
- R. Locking screw
- S. "Exposure" cable release
- T. Millimeter scale (main column)
- U. Lamp arms (adjustable)
- V. Electric outlets
- W. Baseboard
- X. Switch box
- Y. Column locking lever (Model XLR only)
- Z. Column

The two MP-4 models

The MP-4 camera is available in two different sizes. The larger model is available with a rotating column, described below. The camera body and basic operation of both MP-4 cameras is identical.

MP-4 Standard Model:

Total camera height: 46 in. (116 cm)

Column height: 35 in. (90 cm)

Baseboard area, overall:

18 x 23 in. (46 x 59 cm)

Lighting: Four 150 watt 120 volt* reflector floods, run off the 120 volt AC supply.

MP-4 Model XLR:

Total camera height: 66 in. (168 cm)

Column height: 55 in. (140 cm)

Baseboard area, overall:

23 x 29 in. (59 x 74 cm)

Lighting: Four 150 watt 120 volt* reflector floods, run off the 120 volt AC supply.

The column can be rotated about the base, to enable the camera body to be swung to the rear of the baseboard, or to any angle in between. For details on the use of the camera in this way, see page 32.

***220-240 volt areas:** For areas of the world where the voltage is 220-240 volts, a 220-240 volt lighting assembly is provided. Lamps of the appropriate voltage rating must also be used in those areas.

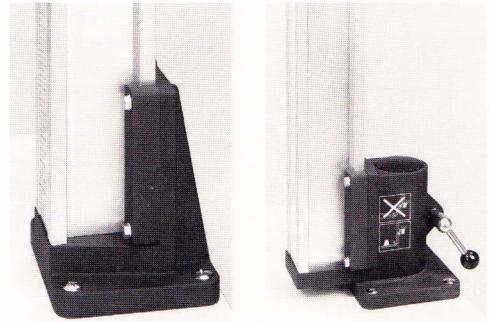

MP-4 Standard (left) has non-rotating column; MP-4 XLR (right) has rotating column.

The sliding camera head

This feature enables you to view and focus the camera without removing the film holder. You simply slide the camera head one way in order to view and focus, and in the opposite direction in order to take a picture. The left section of the head is designed to hold the ground glass and reflex viewer and the right section is for the film holder.

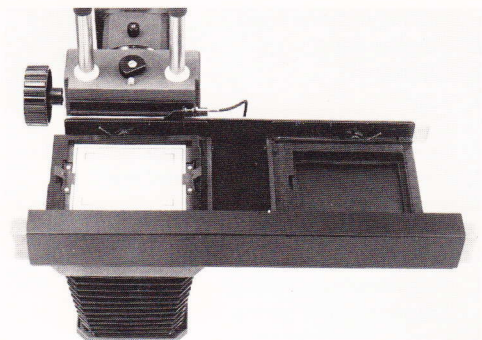

The fixed camera head 44-40 (available in U.S.A. only)

This is an adapter which enables any one of the Polaroid MP-4 film holders to be mounted on the camera. To change from a picture-taking to a viewing position, the film holder must be removed from the camera.

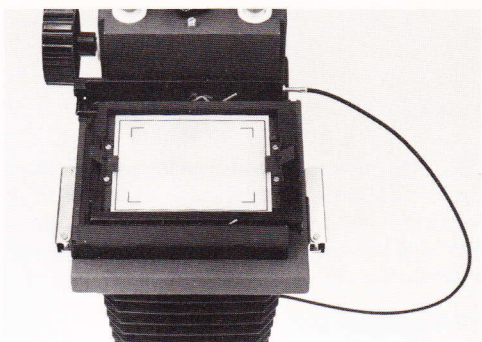

The fixed camera head 44-44

This is an adapter which enables you to mount any one of the Polaroid MP-4 film holders on the camera. It features a reliable locking system which keeps the film holder secure once it has been inserted. This is especially useful when the camera body is tilted or removed from the column; also for photomicrography and photomacrography, when very long exposure times may be necessary. To change from a picture-taking to a viewing position, the film holder must be removed from the camera.

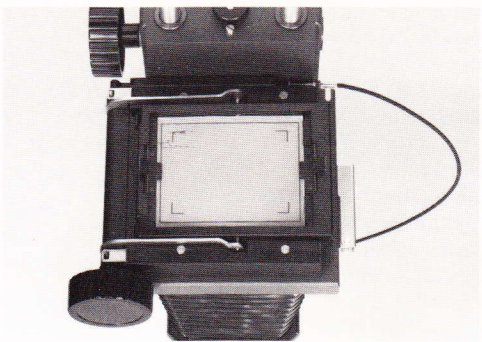

The MP-4 shutter

The MP-4 system uses a self-cocking, lensless shutter. The lenses for the MP-4 do not have built-in shutters; each lens can be attached to the one universal shutter, which is mounted in a lens board, for easy camera attachment.

The shutter speeds range from 1 sec. to 1/125 sec., and there is a "B" setting for time exposures. There is also a flash socket with "X" synchronization. Lens aperture settings are incorporated into each lens.

The shutter accessories are described on page 33.

Lenses for the MP-4

- A. 135mm lens; f/4.5 to f/32
- B. 105mm lens; f/4.5 to f/32
- C. 75mm lens; f/4.5 to f/32
- D. 50mm lens; f/4.5 to f/32
- E. 35mm lens; f/4.5 to f/32
- F. 17mm lens; f/4 to f/22

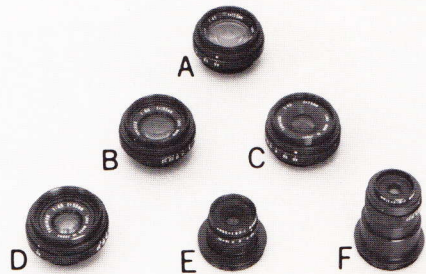

The focusing screens

Three ground glass focusing screens are available for the MP-4. All are for use with Polaroid Land film holders described on the next page. They also can be used with most wet-process 4 x 5 sheet film holders, and some wet-process roll film holders.

They are scribed for Polaroid 4 x 5 sheet film and 3 1/4 x 4 1/4 pack film formats. (The 4 x 5 pack film image area extends from the right-hand marking to about 1/8 in. (3 mm) beyond the left-hand marking.)

Ground glass 44-50: This is a standard ground glass screen, for general-purpose photography.

Aerial image ground glass 44-51: This is a ground glass with a clear-glass circle in the center. The image can be focused on the ground glass in the normal way, or it can be focused in the clear spot as an "aerial image." Aerial image focusing is particularly useful in photomicrography and in some areas of low light-level photography, such as high-magnification photomacrography.

Calibrated ground glass 44-54: It is calibrated in inches and centimeters, to measure reproduction size.

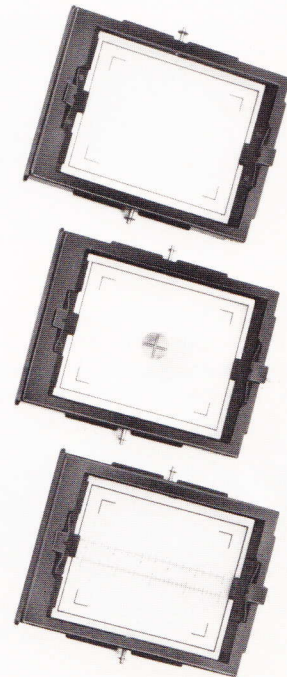

The reflex viewer and hood

This accessory snaps onto the ground glass in the way shown. The viewing hood on the front excludes all ambient light, so that the image on the ground glass may be seen most clearly.

The viewer contains a mirror, which directs the ground glass image forward, rather than upward. This makes viewing and focusing much more convenient.

The image you see is the same you would see on the ground glass alone. However, with the reflex viewer the image will appear the right way up, but reversed from left to right. This reversal will not, of course, appear in your picture.

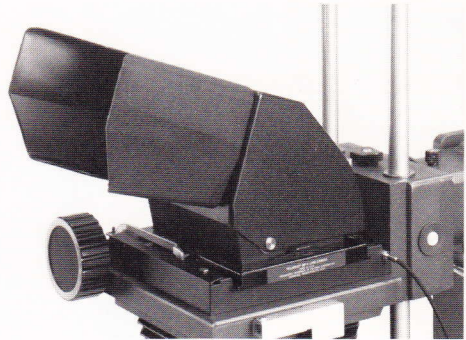
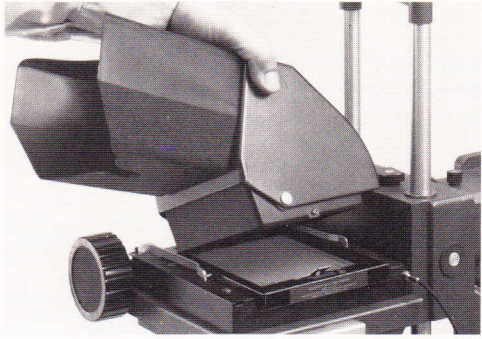

The interchangeable film holders

The MP-4 can be used with the following:

1. Polaroid #545 Land Film Holder for Polaroid 4 x 5 Land sheet films.
2. Polaroid #550 Land Film Holder for Polaroid 4 x 5 Land pack films.

Some MP-4 sliding heads and 44-40 fixed heads must be modified slightly to accept this film holder. Contact Polaroid Corporation (see page 3) for details.

3. Polaroid Land Pack Film Holder 44-48, for 3 1/4 x 4 1/4 pack films.
4. Polaroid Land Pack Film Holder Model 405, for 3 1/4 x 4 1/4 pack films.

With the Model 405 pack film holder, the location of the image area is not the same as that scribed on the ground glasses. For accuracy in composition, a framing template and instructions for its use are provided with the holder.

The Polaroid 4 x 5 film holders and the Model 405 pack film holder can be used with a wide variety of 4 x 5 cameras and instruments, as well as with the MP-4.

In addition, a number of roll and sheet film holders for wet process films can be used with the MP-4.

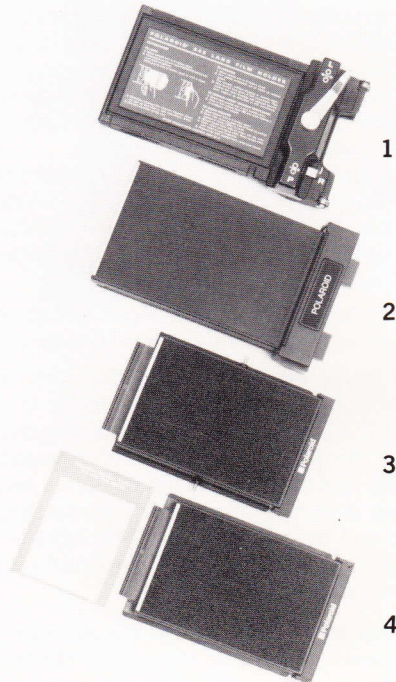

How to attach the 120 volt electrical assembly

Before beginning with the camera assembly, the electrical circuitry should be attached to the baseboard. Turn the baseboard upside down and place it on a flat, clean surface.

1. Attach the switch unit: Screw the box with the two switches firmly to the front center of the lower face of the baseboard, using four of the screws provided. The switches must face outward, as shown. You will find four screw holes in the proper location.

2. Attach the two outlet units: Take the cable coming from one side of the switch unit and carefully lead it around the front edge of the nearest baseboard leg. Lay the cable into the notch specially provided on the front edge of the leg.

About two-thirds of the way toward the back of the baseboard, and near its edge, you will find another four screw holes. Fasten the outlet unit to these, using four more of the screws provided.

Attach the other outlet unit to the opposite side of the baseboard, in the same manner.

This picture shows how the fully assembled 120 volt circuitry should look.

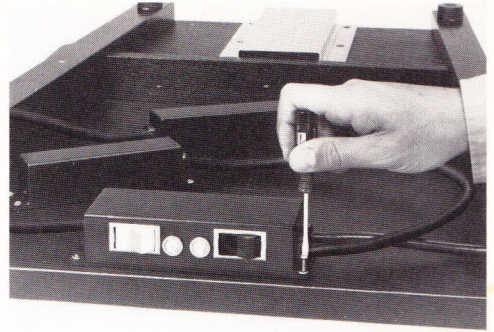

How to attach the 220-240 volt electrical assembly

This circuitry is supplied in one solid U-shaped unit. Simply screw it to the lower side of the baseboard with the screws provided, as shown.



Attach camera column to baseboard

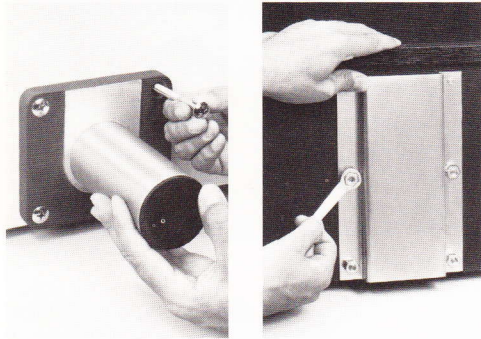

MP-4 Model XLR: Fasten the column post to the baseboard, as shown, using the four nuts and bolts provided. A special wrench is supplied for tightening the nuts; use a suitable screwdriver to hold the bolts while you are doing this. The column post must be positioned as shown, with the milled section (A) pointing toward the

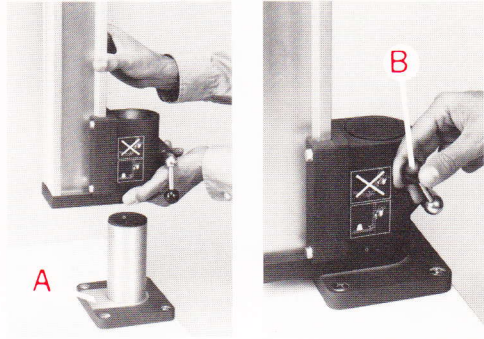

center of the baseboard. Slide the camera column onto the post and secure it firmly with the locking knob (B).

The column of the Model XLR can be rotated through an angle of 180 degrees. For details, see page 32.

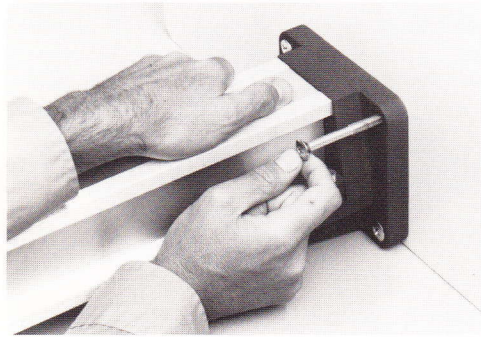

MP-4 Standard Model: The column is most easily attached with the baseboard in a vertical position and the column placed horizontally. Attach the column to the baseboard in such a way that the millimeter scale faces toward the baseboard. Insert the four bolts, first through

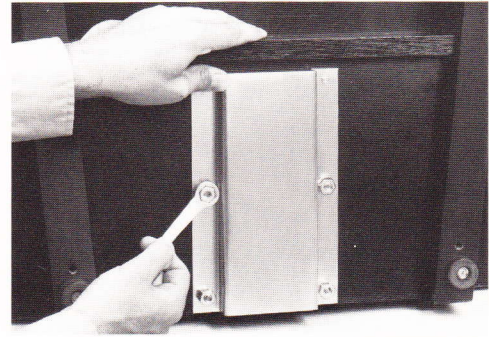

the column base and then through the baseboard. Add the washers, and then the nuts. Tighten the nuts with the special wrench provided; use a suitable screwdriver to hold the bolts while tightening them.

Camera assembly

1. Attach vertical carriage to column: Loosen the locking lever (A) on the carriage by at least one full revolution.

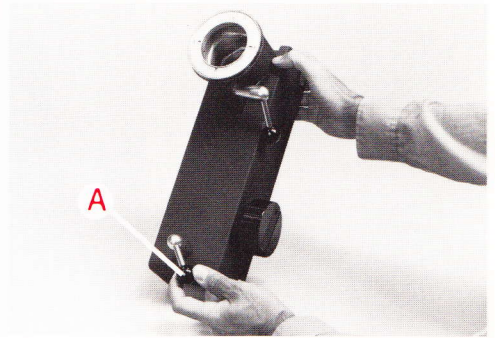

Carefully push the lower end of the carriage onto the column, making sure that the two white rollers (B) slide down behind the rails (C).

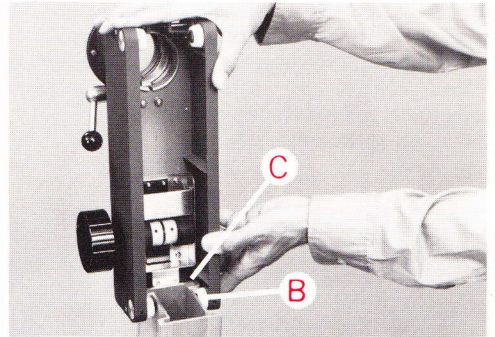

Lower the carriage further, until the two white rollers (D) at the top rest against the top of the column.

Slowly rotate the height adjustment lever (E) in a counterclockwise direction and, as the carriage slowly goes down, make sure the white rollers feed in behind the rails, as shown.

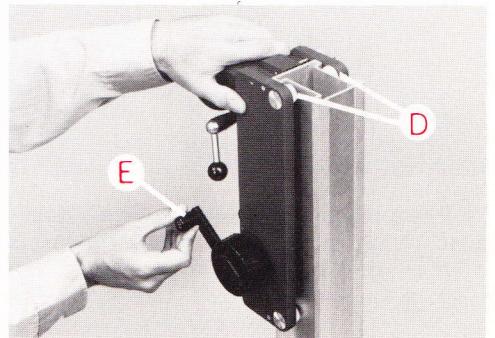

Lower the carriage by about two more inches, and lock it on the column by tightening the locking lever (A).

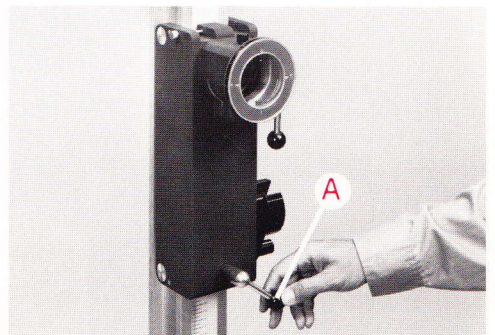

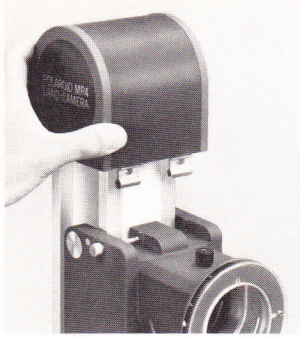

2. Attach spring housing and counterweight spring: Add the spring housing to the column by simply inserting it into the column, as shown, with the spring ends facing the front.

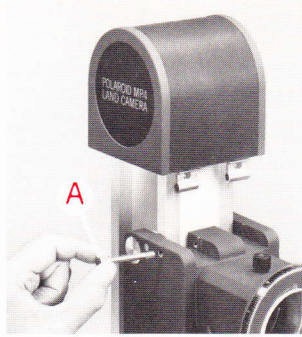

Attach the counterweight spring to the vertical carriage. Remove the pin (A) by unscrewing it and pulling it out.



Unlock the vertical carriage, bring it all the way to the top of the column, and lock it again.

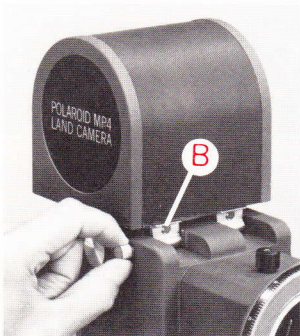

Reinsert the pin, being sure that it goes through the loop (B) at the spring end. Tighten the pin.

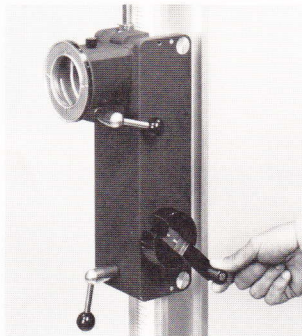

Wind the vertical carriage down the column, until it is at an easily accessible height.

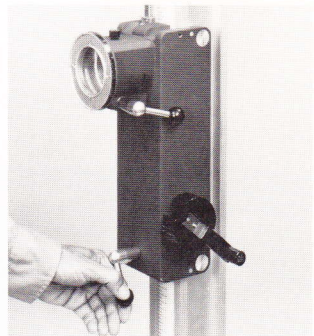

Lock the vertical carriage in position.

WARNING: Never loosen or remove the pin (A) unless the vertical carriage is at the top of the column and locked in position.

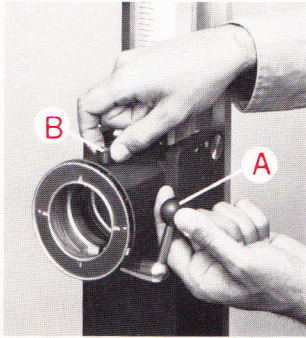

3. Attach camera body to vertical carriage: Loosen the knob (A) until it is in a vertical position, as shown. Also loosen the screw (B) by about three rotations.

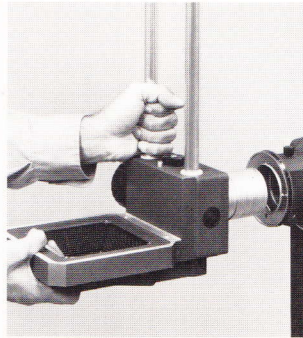

Push the camera body on all the way, as shown. Rotate it back and forth slightly, until

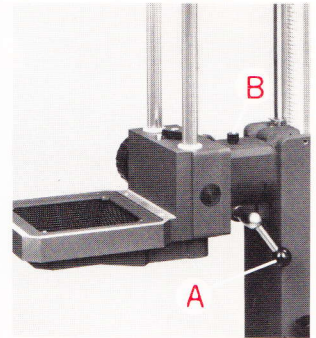

you feel it click into the true vertical position. Tighten (B) and then (A).

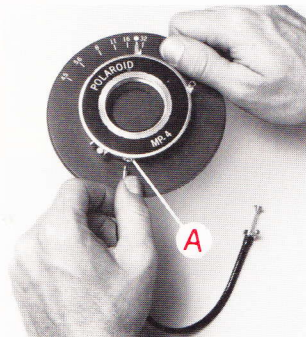

4. Put shutter on camera: First screw the "exposure" cable release into its socket (A).

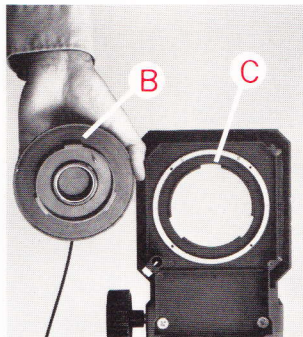

Then align the smallest of the three tabs (B) on the shutter panel with the smallest of the cut-outs (C) on the camera body.



Push the shutter unit onto the camera in that orientation, and rotate it in a clockwise direction until it comes to a firm stop.

CAUTION: When there is no lens on the shutter, the shutter blades are exposed and unprotected. They are very delicate; do not touch them.

5. Attach lens to shutter: Carefully screw the lens that is to be used into the shutter in the manner shown.

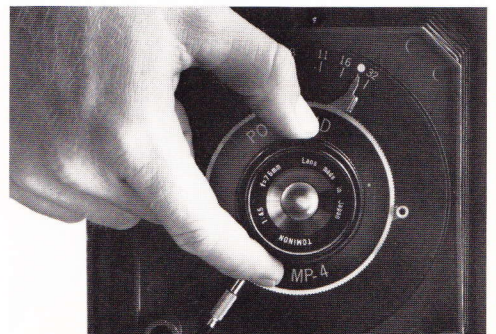

Assembly and use of the sliding camera head

Assembly:

1. Hook the camera head onto the left side of the camera body, as shown.

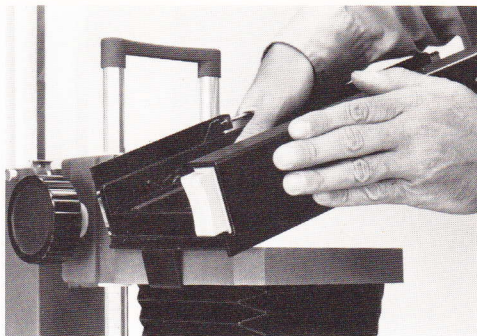

2. Lower the head carefully, taking care that the pins (A) engage in the corresponding holes on the camera body.

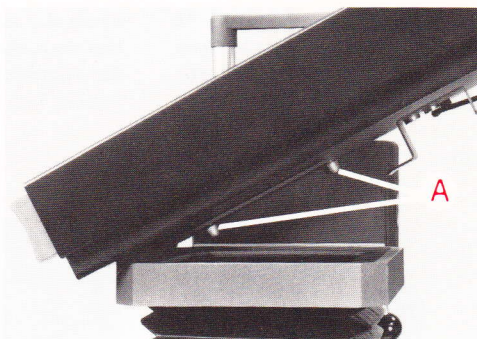

3. Lock the head in place by pushing the latch (B) in toward the camera body.

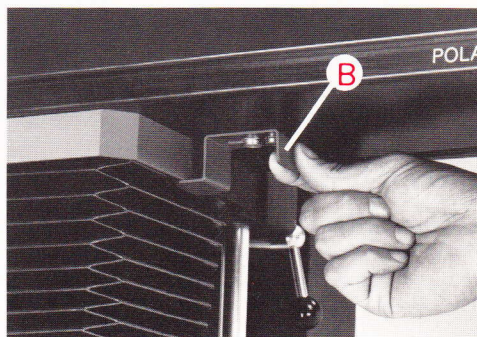

How the camera head slides: To place the left opening in the head (the viewing position) over the camera lens, depress the button (C) and, while holding it in, push the head to the right as far as it will go. To place the right opening (the picture-taking position) over the lens, depress the button (D) and push the head all the way to the left.

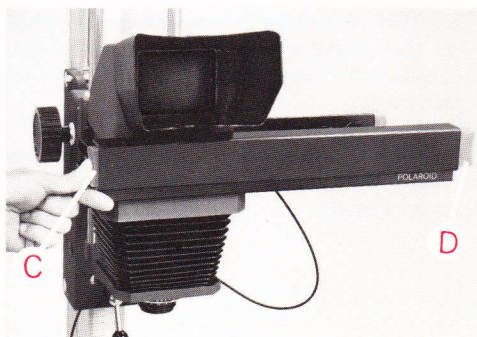

4. Connect the long "pre-view" cable release:

Do this with the camera head in the picture-taking position. It should be pushed all the way to the left.

Attach the release to the shutter, by screwing it into the "pre-view" socket (E).

Set the lens at its largest aperture (smallest f-number).

Look at the shutter from above; the shutter blades should be fully closed. Now push the head all the way to the right, to the viewing position. The shutter blades should open fully. If the above does not happen, you should adjust the plunger end (F) of the release in one direction or the other, until the shutter functions as described.

WARNING: When using the sliding camera head together with heavy accessories, such as one or two macro extensions, always lock the vertical carriage on the column as soon as you have raised or lowered the camera. If you do not, the camera may begin to slide down the column, due to the extra weight.

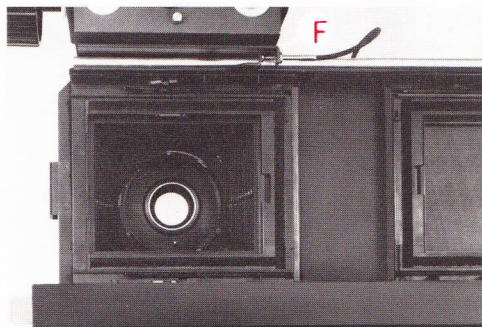
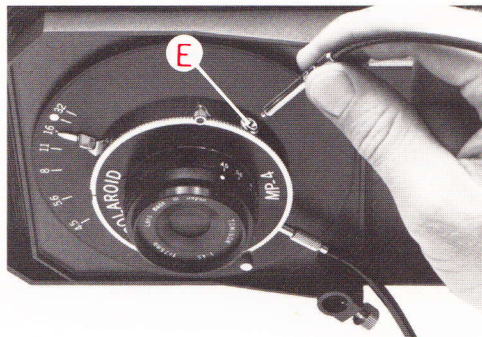

5. Attach the ground glass: One end of the ground glass frame has two small protrusions (G) near its base. Hold the frame in the left hand, with the protrusions pointing to the left.

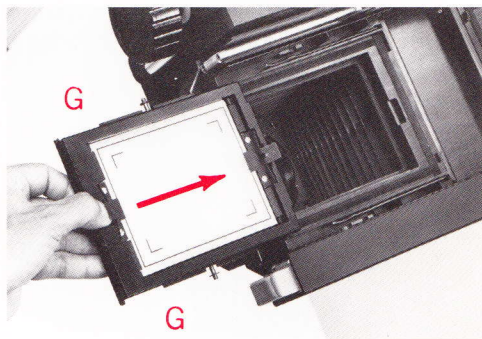

Slide the ground glass frame into the camera head from the left, as shown. Slide it in all the way, so that the two retainer pins on the ground glass frame engage securely in the two spring loops on the camera head.

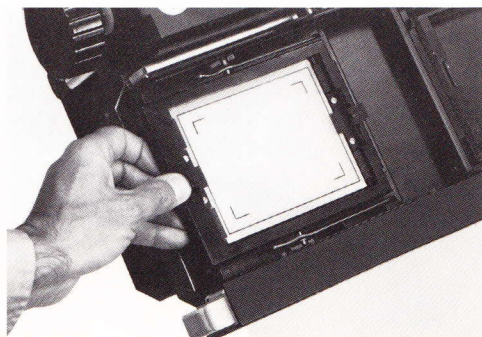

Assembly and use of the 44-40 fixed camera head

1. Attachment: Hold the head so that the hinges of the two latches (A) are nearest you. Open the latches, as shown.

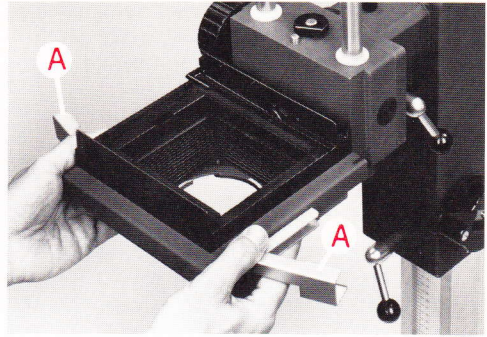

Place the head on the camera body. Be sure it is seated correctly. Push in the two latches (A) to lock the head in place.

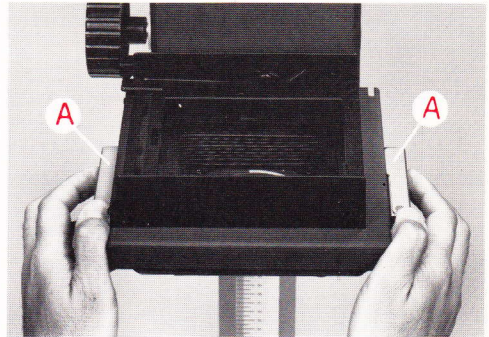

2. Connect the long "pre-view" cable release: Attach it first to the shutter, by screwing it into the "pre-view" socket (B).

Set the lens to its largest aperture (smallest f-number).

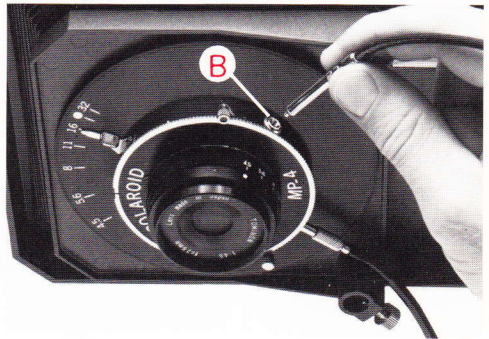

Then attach the plunger end of the release to the camera head, in the following way. Pull out the arm (C) as far as it will go. While holding it there, insert the plunger end of the cable release in the way shown. Secure the plunger end firmly with the two nuts (D).

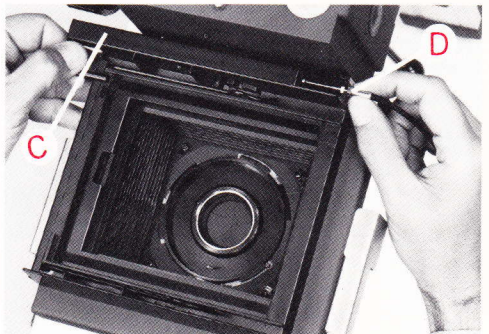

Slowly release the arm (C). Its movement should depress the plunger and cause the shutter to open fully.

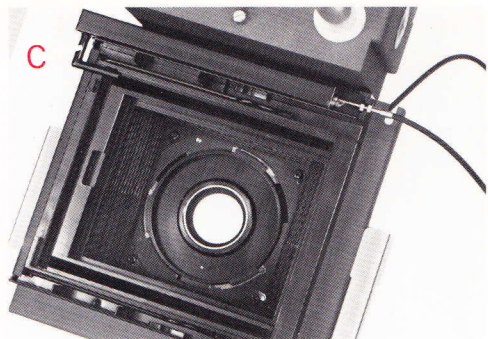

Insertion of a film holder will cause the arm (C) to be pushed out again. This should cause the tension in the cable release to be relaxed sufficiently for the shutter to close fully.

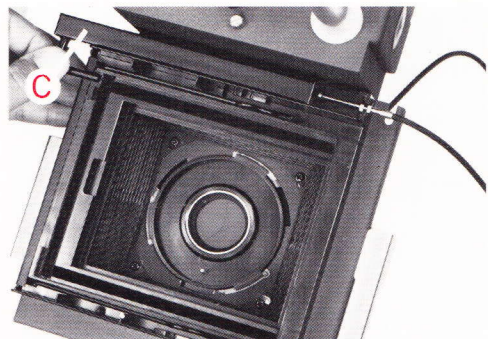

If the shutter blades do not open fully when the arm (C) is relaxed, or do not close fully when that arm is pulled out, then you should adjust the plunger end (D) of the release in one direction or the other, until the shutter functions as required.

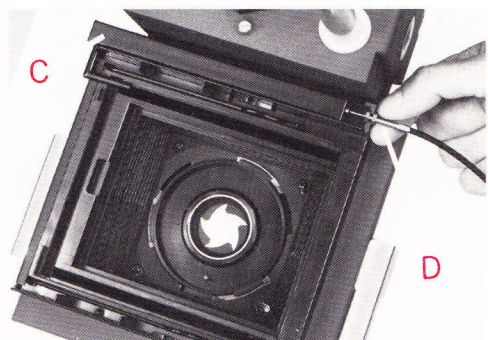

3. Attach the ground glass: First, remove the U-shaped adapter (shown on page 26) from the camera head.

Hold the frame in the right hand, with the small protrusions (E) pointing to the right.

Slide the ground glass frame into the camera head from the right. Slide it in all the way, so that the two retainer pins on the ground glass frame engage securely in the two spring loops on the camera head.

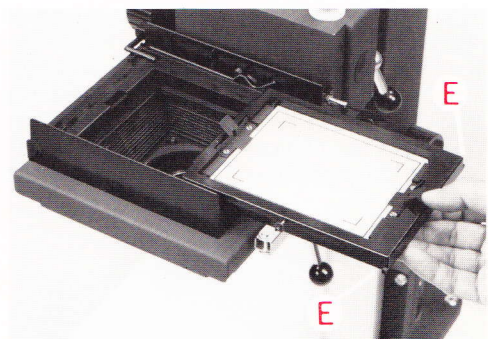

Assembly and use of the 44-44 fixed camera head

1. Attachment: Hold the head so that the hinges of the two latches (A) are nearest you. Open the latches, as shown.

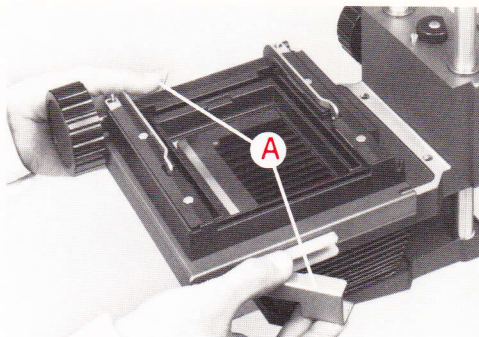

Place the head on the camera body. Be sure it is seated correctly. Push in the two latches (A) to lock the head in place.

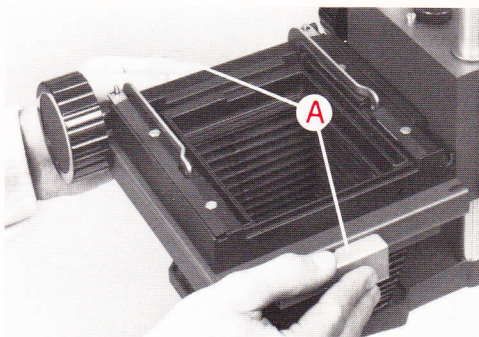

2. Connect the long "pre-view" cable release: Attach it first to the shutter, by screwing it into the "pre-view" socket (B).

Set the lens to its largest aperture (smallest f-number).

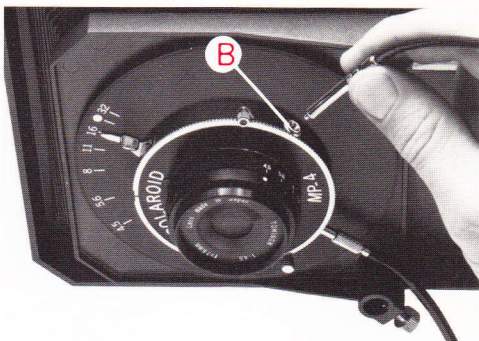

Then attach the plunger end of the release to the camera head in the following way: Turn the knob (C) counterclockwise so that the pin (D) is in a retracted position. Insert the plunger end of the cable release as shown (the tip of the plunger should touch the pin). Secure the plunger end firmly with the two nuts (E).

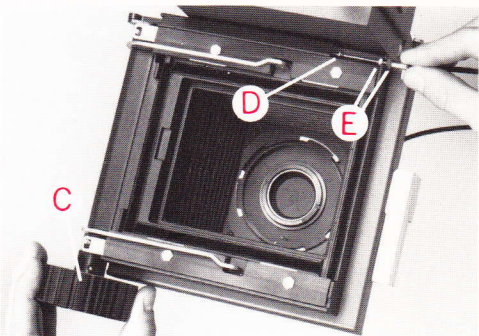

Turn the knob (C) clockwise. The pin (D) should depress the plunger and cause the shutter to open fully.

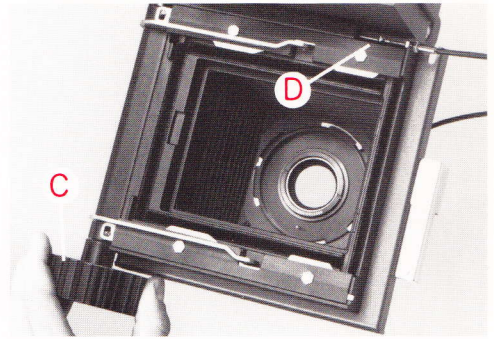

If the shutter blades do not open fully, adjust the plunger end (F) of the release until the shutter functions as required.

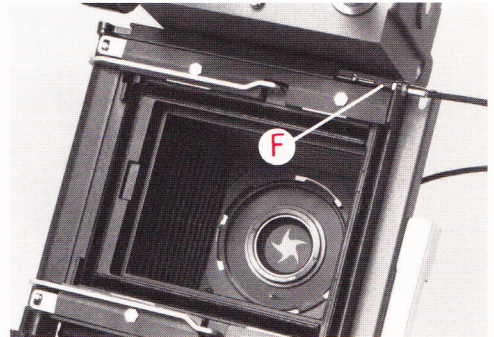

3. Attach the ground glass: Hold the ground glass frame in the right hand, with the small protrusions (G) pointing to the right. Turn the knob (C) counterclockwise as far as it will go, against the pressure of the spring. This will raise the arms (H).

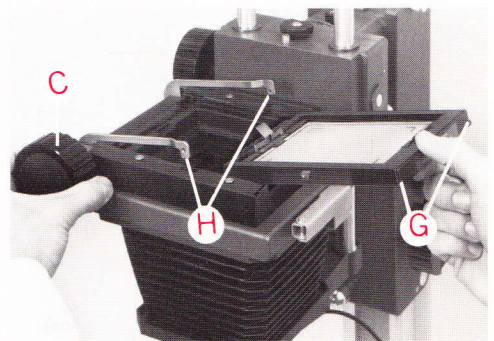

Starting with the side farthest away from you, slide the retainer pin of the ground glass frame into the opening of the arm. Now slide the nearer pin into the nearer arm. If necessary, pull the arm out and over as shown.

Note: Due to the locking system on this camera head, some earlier model MP-4 ground glass frames may not fit properly and should not be used.

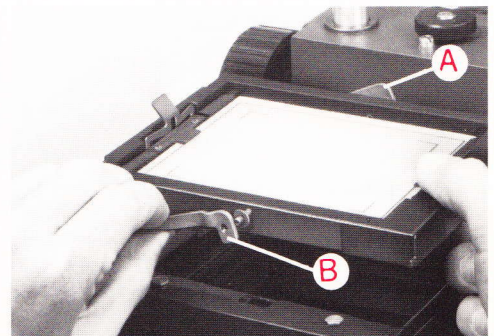

Assembly of lighting system

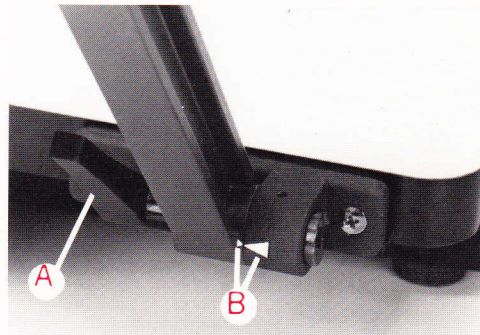
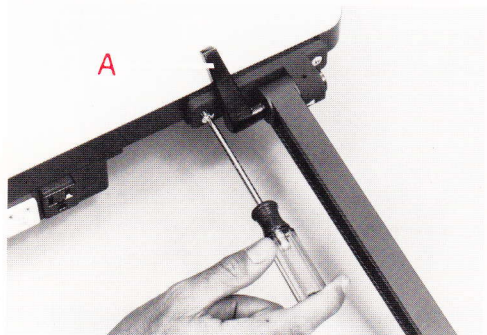

1. Fasten lamp arms to baseboard: The two lamp arms must be fastened to the left and right sides of the baseboard. Use the special locations near the rear edge of the baseboard.

The locking lever (A) on each lamp arm should face the front of the baseboard, as shown. Fasten the lamp arms securely to the baseboard, using the screws supplied with the arms.

2. Angle lamp arms correctly: Angle them as indicated by the two marks (B), and lock them in position with the lever (A). This setting will give you the lamp position that is suitable for most general copy work. For special lighting requirements, the lamp arms may be angled in any way desired. (See page 22.)

RIGHT-HAND LAMP ARM.
MP-4 MODEL XLR.

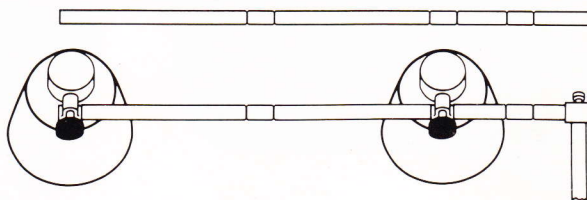

RIGHT-HAND LAMP ARM.
MP-4 STANDARD MODEL.

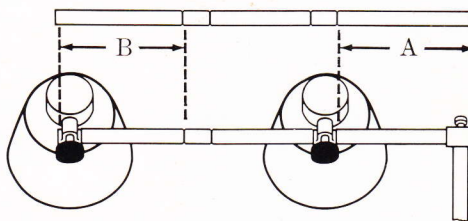

Note: Dimension A is slightly longer than dimension B.

Correct location of cross bars and lamps: The diagrams above show the correct location of arms and lamps for each camera model.

3. Add horizontal cross bars: Slide the cross bar into the top of each lamp arm. Locate the cross bar correctly (see diagrams, previous page), then rotate the bar until the groove (A) points down and the second groove (B) is aligned with the fastening screw (C). Tighten the fastening screw to lock the bar in place.

This picture shows correct attachment for the Model XLR.

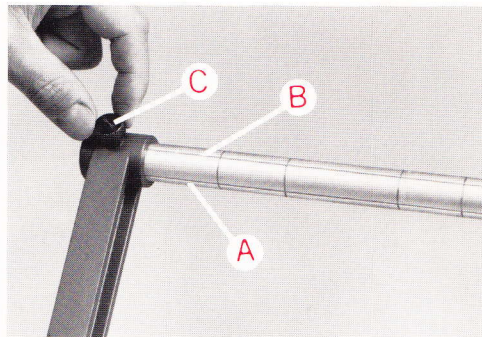

4. Attach the lamps: Each of the four lamps should be attached in the manner shown here, and at the correct location (see diagrams). With the larger baseboard (Model XLR), the two lamps with the longer electric cords should be located near the front of the camera baseboard; the other two at the rear. Each lamp should be pointed down in such a manner that the marker (D) points at the lower groove in the cross bar. Lock each lamp firmly in place by tightening the knob (E).

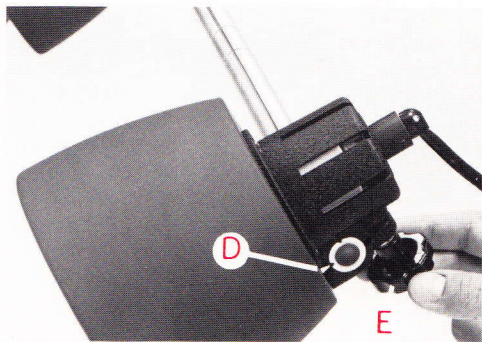

5. Screw in four reflector floods: Screw a 150 watt reflector flood, of the correct voltage, into each lamp socket. For further information about the lamps, and where to obtain replacements, contact the nearest Polaroid office (see addresses, page 37).

Alternative lighting techniques: The lighting is now set up for most regular copying work.

The lighting system is extremely flexible, enabling you to achieve a wide variety of lighting effects. For example, you can change the angle of the vertical lamp arms, alter the position and angle of the lamps on the horizontal bars, disconnect one or more of the lamps entirely, or remove one or more of the lamps in order to use these on separate lamp stands.

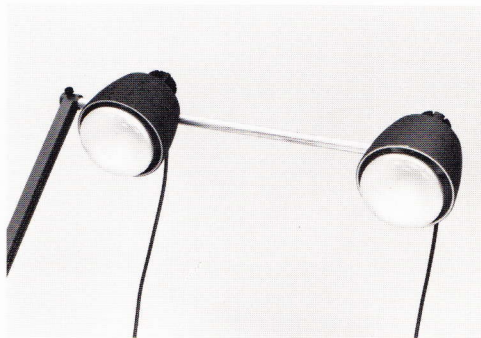

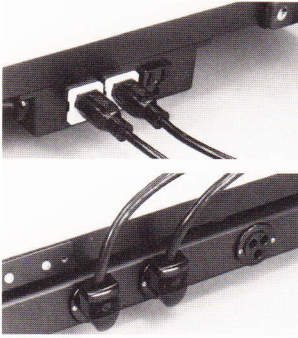

6. Plug in: Use the front two sockets on each side of the baseboard. Top: 120 volt circuitry; bottom: 220-240 volt circuitry.

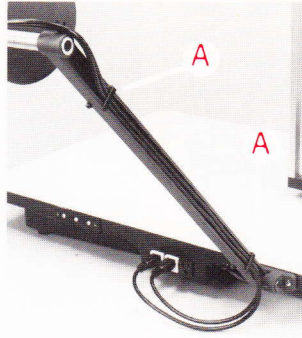

Run the electric cables down the far side of each lamp arm, as shown. Clamp them to the top and bottom of each lamp arm, with the

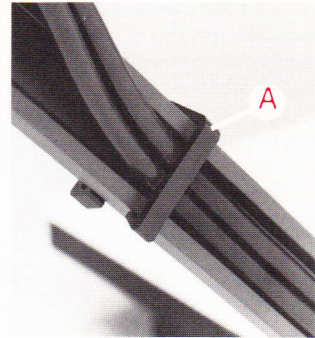

special plastic clips provided (A). Plug the main power cord into the electrical outlet.

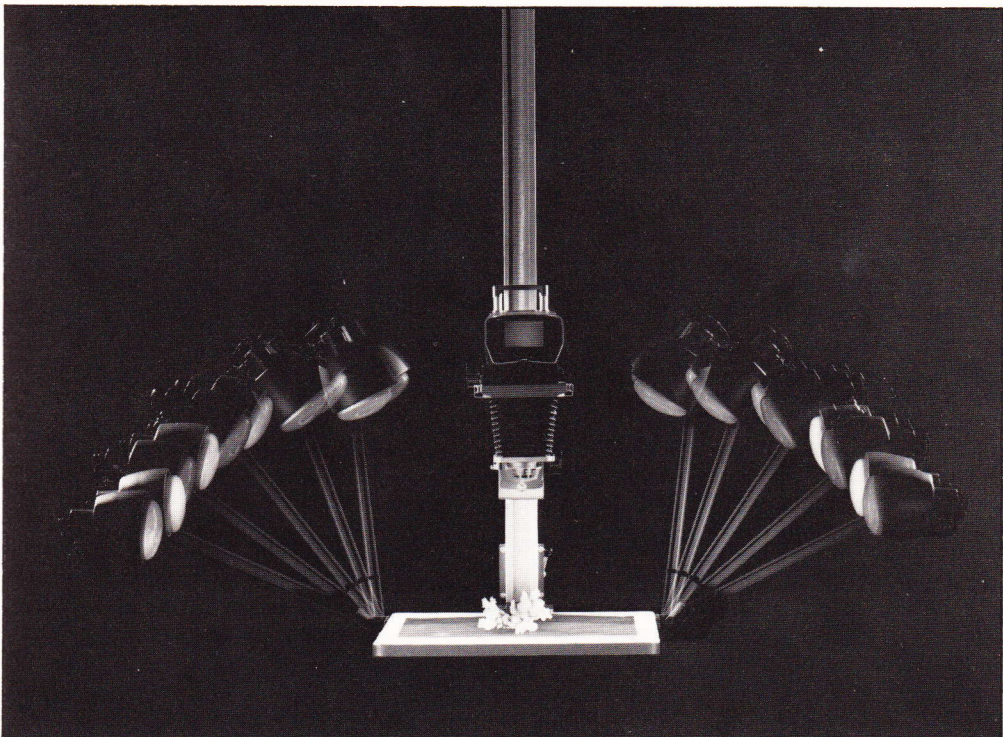

Camera operation

1. Turn on lights: Press the white switch in the front of the baseboard. (Top: 120 volt circuitry; bottom: 220-240 volt circuitry.)

The black switch is for the accessory outlets on the baseboard.

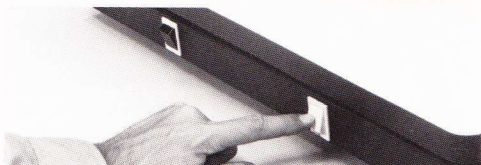
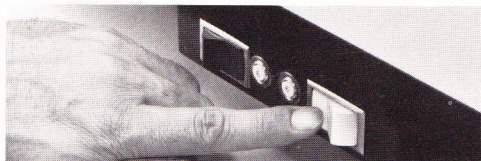

2. Prepare camera for viewing and focusing:

If you are using the sliding camera head, depress the button (A) and, while holding it in, push the head all the way to the right, so that the viewing position is over the camera lens.

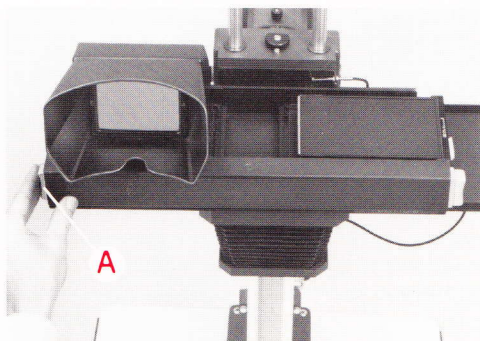

If using the 44-44 fixed camera head, be sure to turn the knob (B) clockwise as far as it will go. This will lock the ground glass in place and open the shutter fully for viewing and focusing.

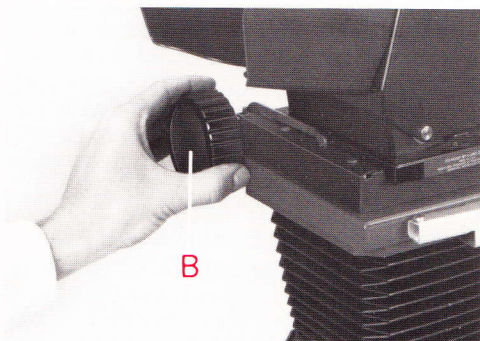

3. Place the material to be copied on the baseboard.

Open the lens aperture fully, to give you as bright an image as possible on the focusing screen.

4. Frame image: If you are using a ground glass only, the image on this will appear upside down. If you are using a reflex viewer, the image will appear right way up, but reversed left to right.

Turn the locking lever (C) in a counter-clockwise direction, to free the camera for movement up or down the column. While observing the image through the ground glass, raise or lower the camera by turning the height adjustment lever (D) until the image is roughly of the required size.

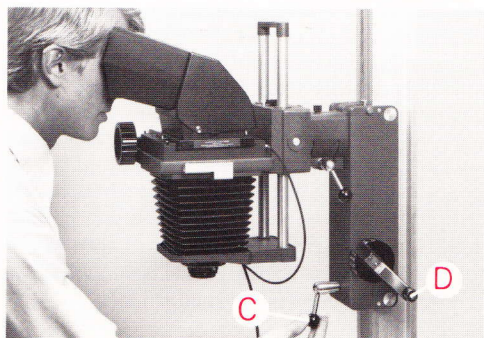

5. Focus: Adjust the focusing knob (E) until the image is sharp. Normally, at this point, the image will not be exactly the correct size. Adjust the camera height again, as described in (4) and refocus. You may have to repeat this two or three times, before you get the image both exactly the right size and also in focus. Finally, lock the camera in position on the column by turning the locking lever in a clockwise direction, without excessive force. Center the original on the baseboard in the way you wish to reproduce it. Remember to follow the ground glass marking which is correct for the film format you are using.

Basic focusing rule: To increase the size of the image on the ground glass screen, you must lower the camera and increase the bellows extension. To decrease the size of the image, you must raise the camera and decrease the bellows extension.

Normally you should adjust the camera height first to get roughly the image size you need, and then adjust the bellows extension to give you sharp focus.

However, when you are working at or near the 1:1 reproduction scale (that is, when original and ground glass image are nearly the same size) it becomes virtually impossible to focus by bellows adjustment. At such a setting, you must reverse the procedure described, and adjust the bellows first to get the approximate image size required, and then attain sharp focus by adjusting the camera height.

Camera column scales: There is a millimeter scale on the main camera column. When read at the point indicated, it represents the film plane to baseboard distance for Polaroid sheet and pack films. A second millimeter scale, on the left focusing column, represents the bellows extension, when it is read at the point indicated. These scales can be useful if your work requires you to frequently reset the camera for one, or several, specific reproduction ratios. Just write down the two respective readings for the camera settings involved, and you can eliminate a lot of repetitive refocusing.

Note: If the **exact** reproduction scale must be documented, place a ruler on the baseboard and photograph it with the original subject.

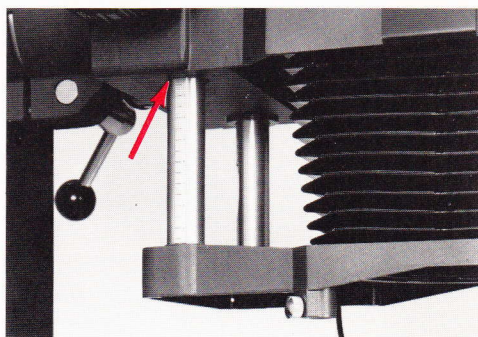
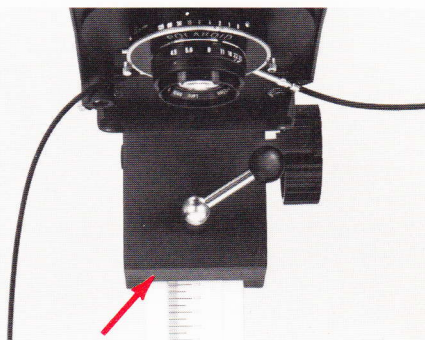
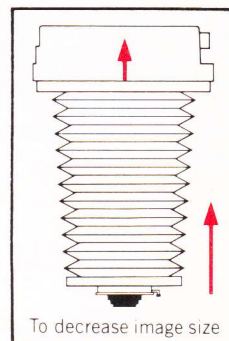
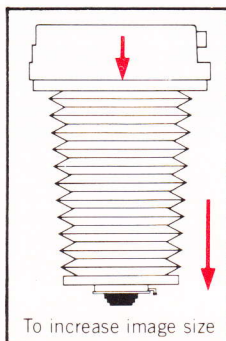
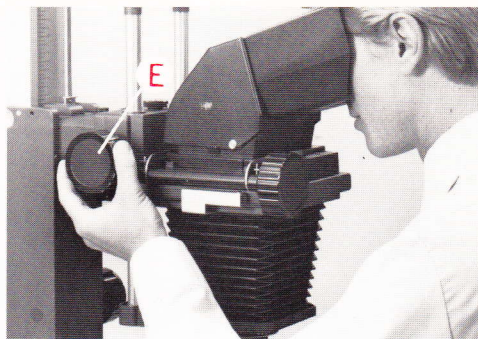

6. Prepare camera for taking picture: If you are using the sliding camera head, depress the button (F) and, while holding it in, slide the head to the left as far as it will go.

For details on how to insert a film holder, see the next page.

7. Set shutter speed and lens aperture for correct exposure: First, determine the correct exposure for the conditions in which you will be working. Among the factors to be considered are film speed, nature of the subject being photographed and reproduction ratio. An exposure guide for the MP-4 camera and Polaroid Land films is available; contact the nearest Polaroid office (see page 37).

To set the shutter speed, turn the silver ring to place the indicator (G) at the desired speed. It will click into position. Never set the indicator between shutter speeds.

To set the lens aperture, turn the lens ring to place the desired aperture opposite the dot (H). The ring will click into position. The lens may also be set between full aperture settings.

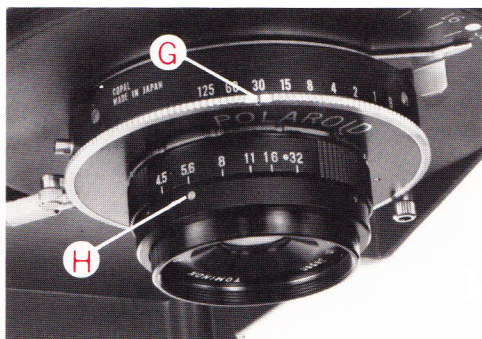
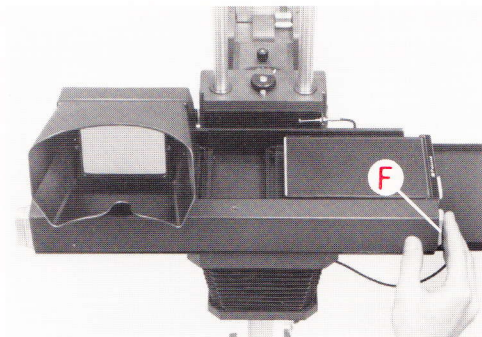

Guide to exposure control

Exposure is the amount of light that reaches the film through the lens. It is controlled by the length of time the shutter is open (shutter speed) and the size of the opening in the lens (lens aperture).

The shutter stays open for the length of time indicated on the ring. The numbers signify fractions of a second; thus, 60 = 1/60 sec., 4 = 1/4 sec., 1 = 1 sec., etc.

The lens opening can be made larger or smaller. The size of the opening is measured in f-numbers, which are marked on the lens ring. The highest f-number indicates the smallest opening; the lowest f-number indicates the largest opening.

Each lens opening will admit either twice as much or half as much light as the one next to it on the ring. Thus, changing from f/11 to f/8 will double the exposure; changing from f/11 to f/16 will cut the exposure in half.

Shutter speeds							
125	60	30	15	8	4	2	1
← Darken/Lighten →							
Lens openings							
4.5	5.6	8	11	16	22	32	
← Lighten/Darken →							

To increase exposure (make pictures lighter), use a longer exposure time (slower shutter speed), or a larger lens opening (aperture). To decrease exposure (make pictures darker), use a shorter exposure time (faster shutter speed), or a smaller lens opening (aperture).

How to insert the Polaroid Land film holders

Insertion in sliding camera head

44-48 pack film holder: Slide the holder into the right side of the camera head. Slide it in all the way, so that the two retainer pins (A) on the holder engage the springs on the camera head.

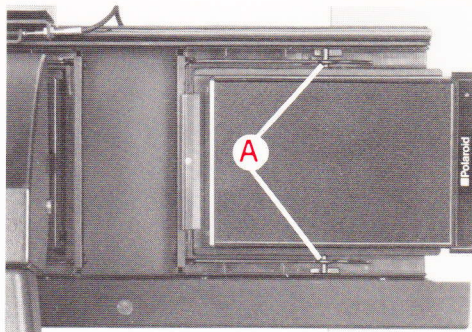

Remove the ground glass and reflex viewer from the left side of the head, then withdraw the dark slide from the holder. Replace the ground glass and reflex viewer.

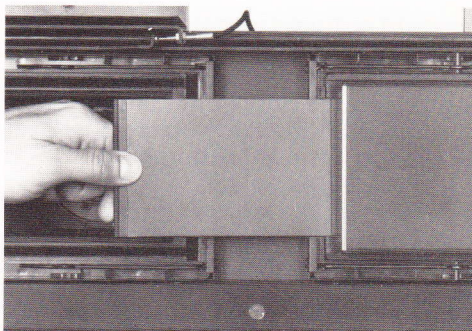

#545, #550 and Model 405 film holders: You must first attach the special U-shaped adapter, provided with the head. With the open end of the "U" pointing to the right, slide the adapter into the right-hand section of the camera head, as shown. The two pins (B) must engage in the spring loops (C).

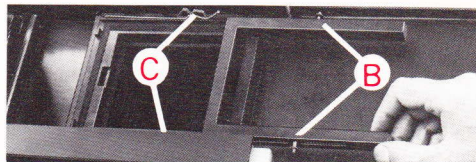

The #545 film holder can be loaded while inserted in the camera; the other film holders must be loaded beforehand.

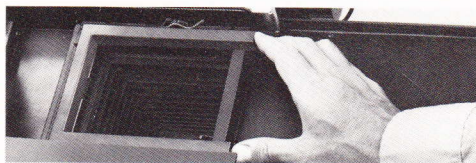

Slide the film holder under the U-shaped adapter, as shown. Push it all the way in, so it is firmly seated.

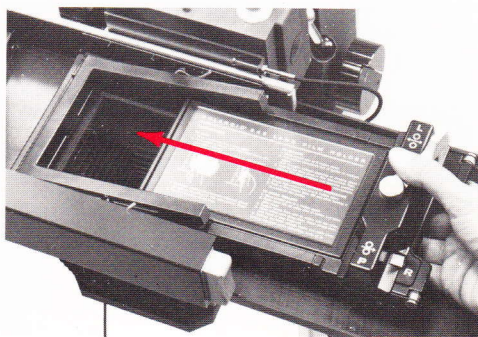

Insertion in 44-40 fixed camera head

Insertion is the same for all film holders. The #545 film holder can be loaded while inserted in the camera; the other film holders must be loaded beforehand. Push the film holder in below the focusing screen, from the right. Push it in all the way. The focusing screen and the springs will hold it firmly in place.

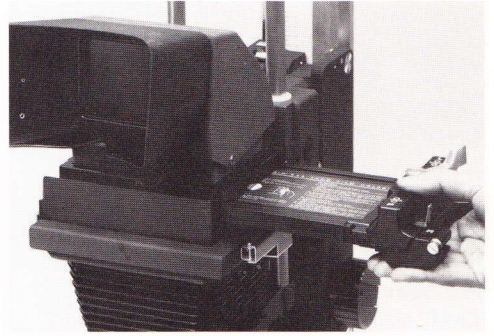

Insertion in 44-44 fixed camera head

Insertion is the same for all film holders. The #545 film holder can be loaded while inserted in the camera; the other film holders must be loaded beforehand. Turn the knob (D) counterclockwise as far as it will go. This will lift the ground glass and reflex viewer.

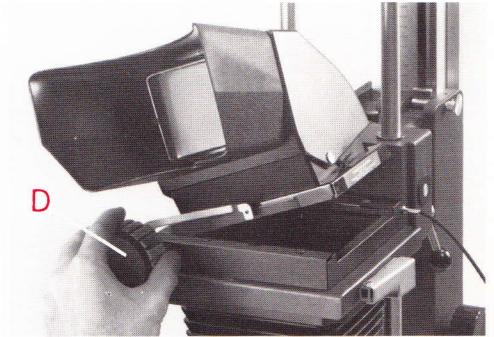

While holding the knob in this position, push the holder all the way in. Slowly release the knob. Make sure the holder is properly positioned, then turn the knob clockwise as far as it will go, to lock the holder in place. When the holder is in place, turning the knob to this position will not open the shutter, as it does when previewing.

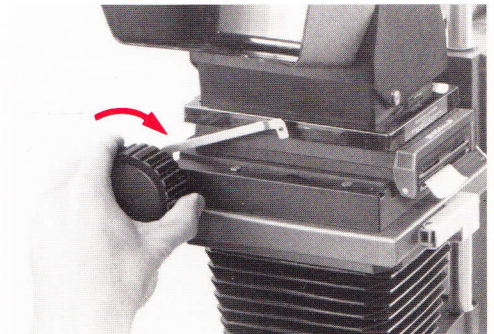
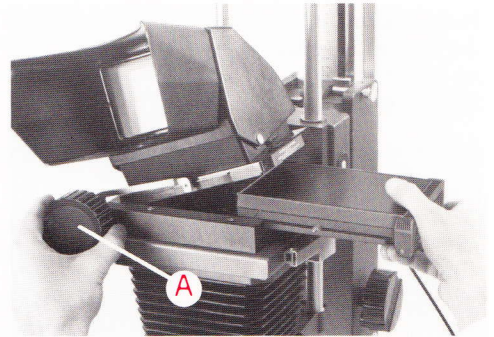

How to use the Polaroid Land Pack Film Holder 44-48

Instructions for use of the other film holders are provided with the holders.

Load the film

Push the latch to open the door; the door does not open flat. Before loading the film, check that the developer rollers in the holder are clean (see **KEEP THE DEVELOPER ROLLERS CLEAN** page 30).

Always hold the film pack by the edges, not in the center. Slide the pack in at an angle, then push it down into place.

Check that the white tabs are not caught between the pack and the holder. Close and latch the door, with the end of the black tab sticking out.

Pull the black tab straight, all the way out of the holder. A small white tab will appear. (If no white tab appears, see **POSSIBLE PROBLEMS** page 30.)

Attach the film holder to the camera: See pages 26 and 27.

Taking the picture: With the camera loaded and the subject framed and focused, proceed as follows:

1. Determine the correct exposure, and set the shutter speed and lens aperture accordingly.
2. Set the sliding camera head, if you are using it, into the picture-taking position.
3. If you are using the fixed camera head, you should now pull the dark slide (A) out of the film holder. You can either pull it out all the way, or just far enough for the red strip (B) to appear.

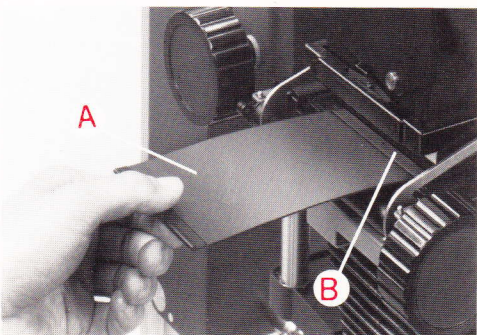
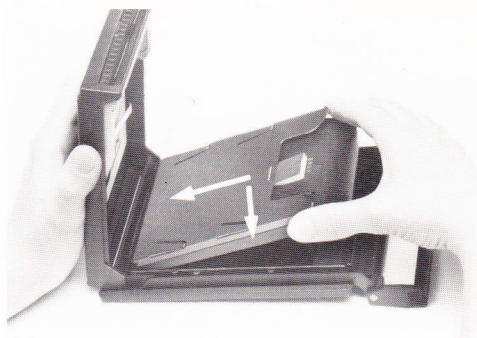

4. Make the exposure, by depressing the cable release attached to the shutter.

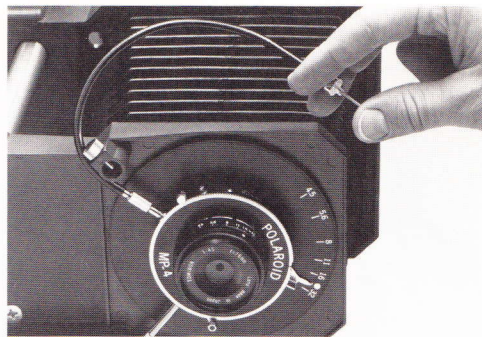

Process the film

Pull the white tab straight, all the way out of the camera. A large yellow tab will appear. If no yellow tab appears, see POSSIBLE PROBLEMS, page 30.

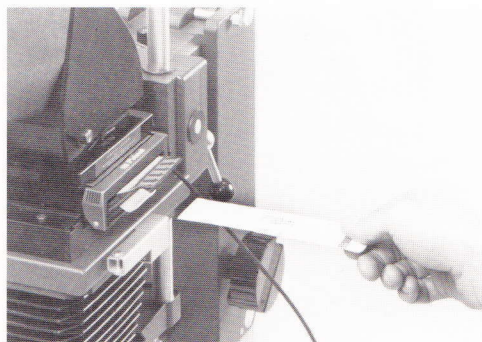

Grip the yellow tab firmly, and pull it **straight, at moderate speed**, without hesitation, all the way out of the camera. The picture is now developing, so start timing.

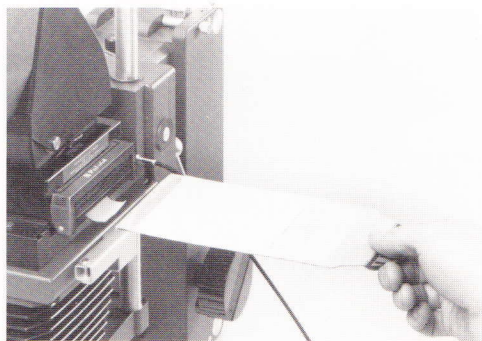

Develop the picture for the full time recommended in the film instructions. Then separate the print from the negative, starting at the end nearest the yellow tab. Information on handling of prints and negatives is in the film instructions.

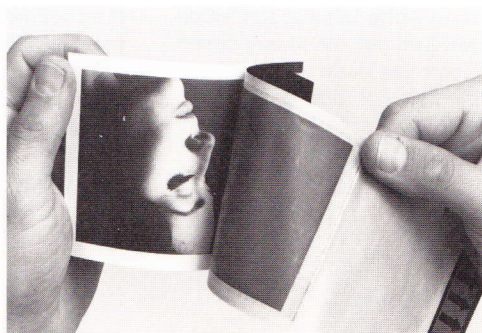

Caution: The Polaroid Land film process uses a caustic jelly which is safely packed inside sealed containers within the film pack. **If accidentally you should get some of this jelly on your skin, wipe it off immediately.** To avoid an alkali burn, wash the area with plenty of water as soon as possible. **It is particularly important to keep the jelly away from eyes and mouth.** Keep discarded materials out of reach of children and animals and out of contact with clothing and furniture, as discarded materials still contain some jelly.

Keep the developer rollers clean

Dirt or dried developer on the rollers can cause a variety of picture problems.

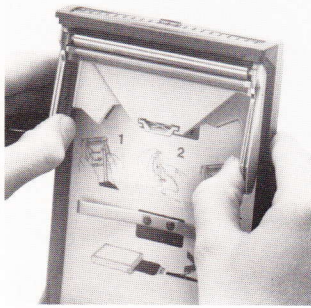

With both hands, lift the steel loops, and remove the roller assembly.

Inspect the rollers before loading the film, and clean them if necessary.

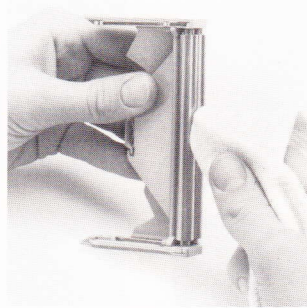

Clean both rollers with a damp, lint-free cloth. Never scrape them with anything metallic, nor with your fingernail. Rotate both rollers as you clean and inspect them.

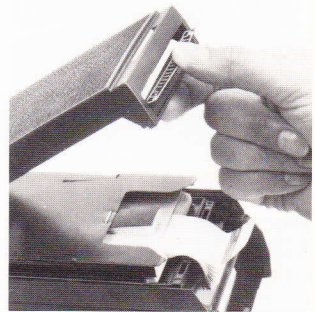

Also clean the film tab slot. Then replace the roller assembly.

Possible problems



If no white tab appears when you pull out the safety cover: Open the door and, without moving the film pack, push the white tab out. Then close and latch the door.

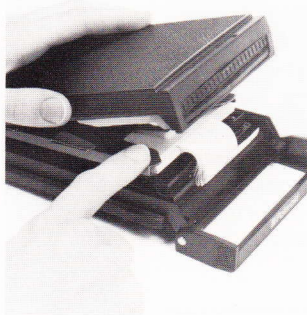

If no yellow tab appears when you pull the white tab: Do not pull another white tab. Instead, carefully open the holder far enough to get a finger on top of the film to hold it down.

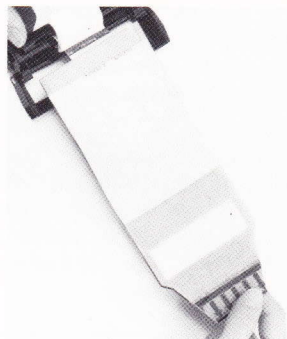

Grasp the topmost yellow tab, and gently pull it all the way out and discard it. Inspect the rollers and clean them if necessary. Close and latch the holder, with the next white tab sticking out.

Camera tilt

The camera can be tilted through a full 360 degrees. To tilt the camera, loosen the locking knob (A) and turn the camera by the required amount. The correct angle of the camera is indicated by the pointer (B). To aid camera orientation, the camera clicks into place when in a true vertical or horizontal position, relative to the baseboard. When at the correct angle, lock the head again with the locking knob (A).

Be sure that the camera head, the ground glass, and the film holder are secure on the camera, so that they do not drop off on rotation. It is advisable to remove the reflex viewer.

For copying material on a wall, rotate the camera to the right (see bottom picture), so that the tab end of the film holder points upward. Remove, or lower, the lamp arm on the right side of the baseboard. The material on the wall will have to be lit separately; you can use the regular MP-4 lamps, on separate stands, for this.

Be sure that the material is lit evenly, and that no stray reflections are entering the lens. Be sure the camera is centered with the material and perpendicular to it.

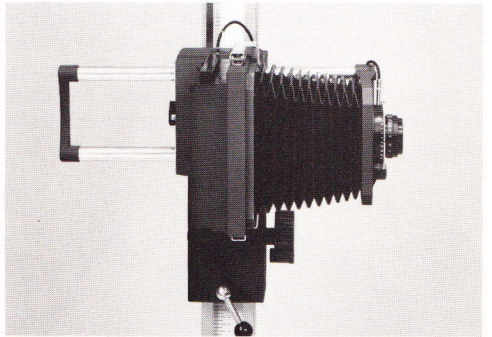
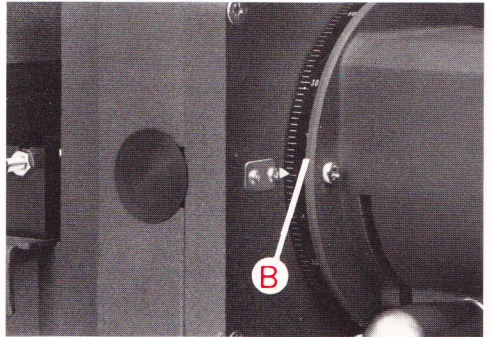
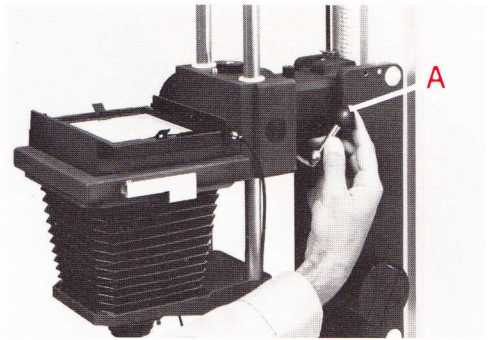

Camera column rotation on MP-4 Model XLR

The column of the MP-4 Model XLR can be rotated through an angle of 180 degrees, so that the camera is aimed toward the floor rather than at the baseboard. This position can be useful if you wish to photograph something that cannot be easily accommodated on the baseboard.

WARNING: Before you rotate the camera, be sure to place an object, or objects, of adequate weight on the baseboard, so as to prevent the camera from falling over. This warning is included, as a special reminder, near the base of the camera column itself, by the two sketches shown here.

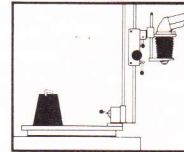
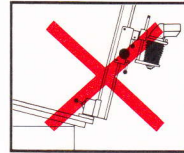

To rotate the column, loosen the column locking lever (A), turn the entire column to the desired position, and lock the lever (A) again.

Leave the weights on the baseboard until the camera head has been brought back to its normal position.

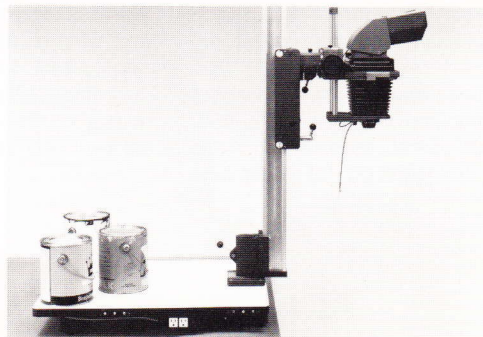
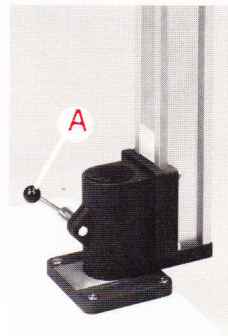
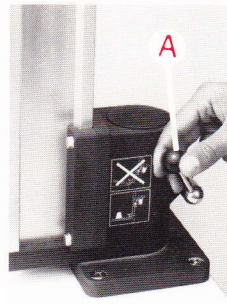

Camera body removal

You can remove the camera body from the MP-4 column, either to use the camera on a conventional camera stand or tripod, with the aid of the tripod adapter shown on page 34, or to use some other camera on the MP-4 column, with the universal camera mount also shown on page 34.

To remove the camera body, loosen the locking knob (A) until it is in a vertical position, as shown. Then loosen the retainer screw (B) by about three full rotations. Pull off the camera body, as shown.

To replace the camera body, first be sure the locking knob (A) is loosened by no more than a half rotation, and the retainer screw (B) is loosened by about three full rotations. Push the camera body on all the way, and tighten (B) and then (A).

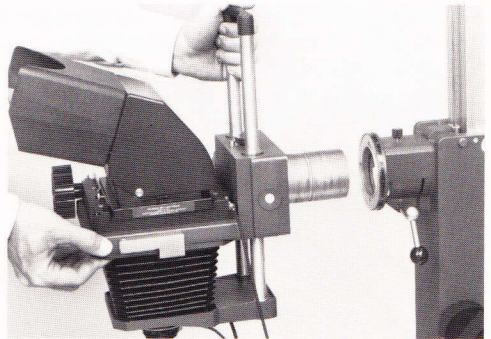
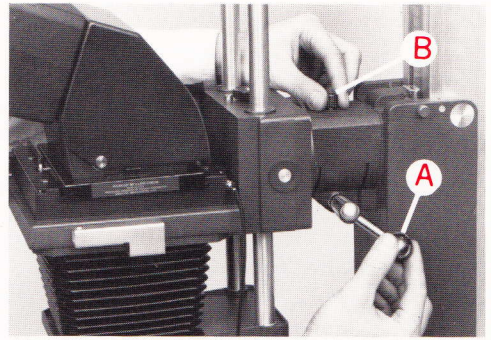

MP-4 shutter accessories

The MP-4 shutter kit includes the shutter, cable release, reduction accessories and microscope adapter.

The reduction accessories are designed for extreme reductions, generally for producing slides. They are used with the 75mm lens, in conjunction with an appropriate film holder for conventional small-format films. The microscope adapter is attached to the shutter in place of a lens, for photomicrography. Instructions for both applications are provided with the kit.



Some other useful camera accessories

Macro extension 44-45: When added to the camera, between the bellows and the camera head, as shown, it enables you to make macrophotographs up to a magnification of about 27x, using a 17mm lens. You can use two extensions to increase the magnification range accordingly.

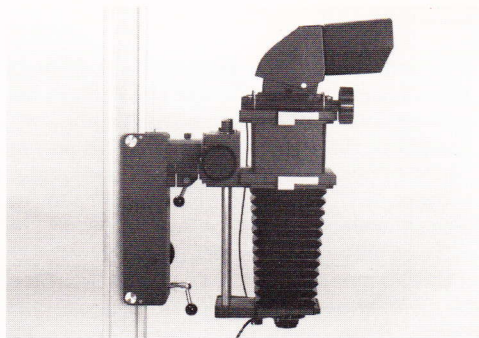

MP-4 tripod adapter 44-81: For mounting the camera on most standard tripods or studio stands. Thus, the MP-4 can be converted into an excellent studio camera for portraiture, large-scale copying, and many other uses which do not demand the availability of camera swings and tilts.

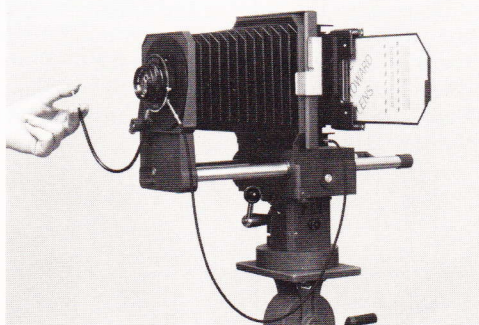

Universal camera mount 44-85: To convert the MP-4 into a 35mm copying or slide making system. The MP-4 camera head is removed, and the mount is attached to the column in its place. Virtually any 35mm camera, and many conventional cameras of other formats, can be used on the mount.

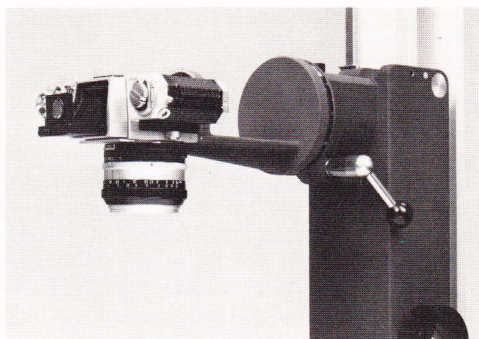

SLR T-adapter plate 44-83: It enables you to use the MP-4 camera system and lenses with a 35mm single-lens reflex camera. It is intended mainly for photomacrography. (Available outside U.S.A. only.)

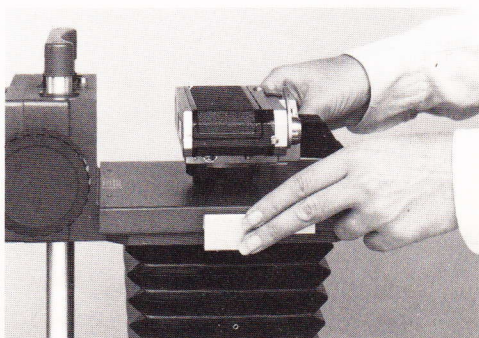

MP-4 filter kit

The filter kit is available as an accessory. It includes a filter holder with two filter trays, gelatin filters and a filter frame. The filters are intended to balance the MP-4 lighting for use with Polacolor film. Filters for other purposes may be used also, as required. Complete instructions are included with the kit.

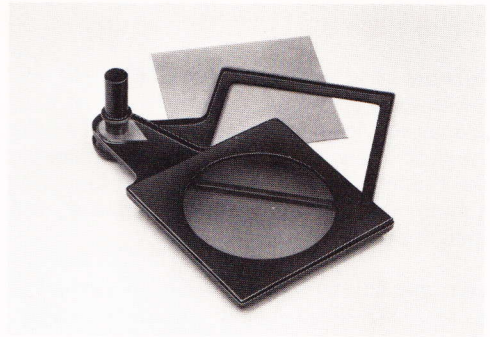

Other filter attachment methods

On the right are shown some other methods of attaching filters to the MP-4 lenses.

Any of three types of adapter rings may be used: Set-screw ring (A) slips loosely over the front of the lens mount and is held in place by a set-screw; Slip-on ring (B) slips tightly over the front of the lens mount and is held in place by friction; threaded ring (C) screws into the front mounting threads of the lens. These adapter rings take glass filters.

Alternatively, a 2 in. square gelatin filter frame holder (D) may be attached to the above adapter rings in place of a glass filter. The gelatin filter should be mounted in a filter frame before insertion into the holder.

A step-up ring (E) enables you to use the Series 6 filters with the 35mm and 17mm lenses as well as with the other MP-4 lenses.

The table below lists the specifications for Tiffen adapter rings and glass filters for the MP-4 lenses.

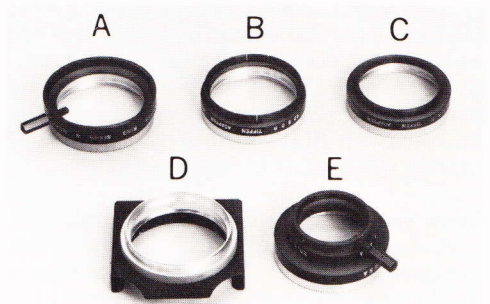

Tiffen Adapter rings

Lens	Filter size	Set-screw	Slip-on	Threaded
135mm 105mm 75mm 50mm	Series 6	42 SS 6	42 SO 6	39.5 M 6
35mm	Series 5	28.5 SS 5	28.5 SO 5	27 F 5
17mm	Series 5	24 SS 5	24 SO 5	22.5 F 5

"Tiffen" is a registered trademark of the Tiffen Manufacturing Company.

MP-4 care and maintenance

Polaroid Land film holders: The two steel rollers in each of the film holders must be kept absolutely clean, to prevent spots and marks on your Polaroid pictures. Always examine the rollers carefully before loading film. Use a damp cloth to remove foreign matter, and then dry thoroughly.

Lens and shutter: Never touch the surface of a lens. If you should get fingermarks, smears, etc. on a lens, these can be removed by wiping gently with lens tissue or a soft, lint-free cloth. The elements in each lens are precisely mounted and aligned by the manufacturer, and should be removed only by qualified camera repair technicians. The shutters are lifetime lubricated; do not attempt to either oil or adjust them.

Reflex viewer: The reflex viewer contains a front-surfaced mirror, which will scratch and damage easily. Do not touch it. If you should get fingermarks on it, wipe it gently with a soft, lint-free cloth. For the removal of dust, use an antistatic brush.

Moving parts: Never attempt to lubricate any part of the assembly. All moving parts are lubricated at the factory, for smooth operation over a long period of time. Keep all parts of the camera clean, and cover the entire unit when not in use.

Spare parts: There are small parts which may occasionally require replacement due to loss or accidental damage. For information on parts that may be replaced by the camera owner, and for a supply of such parts, please contact Polaroid Technical Assistance (page 3) or the nearest Polaroid office (see addresses on next page).

Registration

The serial number of your MP-4 camera is stamped on the name plate located at the rear of the camera column, near the bottom. Please register this number with Polaroid Corporation by completing and returning the registration card packed with the unit. You will then be placed on our mailing list, to receive information about new Polaroid photographic products and literature.

Warranty

Your Polaroid MP-4 Land Camera has been thoroughly inspected and tested before shipment. All parts are guaranteed against defects in materials and workmanship for one full year from the date of original purchase. During this period any such defects will be remedied by Polaroid Corporation without charge, except for transportation costs.

THIS WARRANTY EXCLUDES ALL CONSEQUENTIAL DAMAGES.

Servicing

Cameras damaged by mishandling or worn from normal use will be promptly repaired at a reasonable charge. Please pack the camera carefully in a solid container, with plenty of padding, and ship it, prepaid and insured, to the nearest Polaroid Service Center.

Polaroid Service Centers and Offices

California

Polaroid Corporation
3232 West MacArthur Boulevard
Santa Ana 92704
Telephone: (714) 641-1200

Georgia

Polaroid Corporation
5601 Fulton Industrial Blvd., S.W.
Atlanta 30378
Telephone: (404) 346-1717

Illinois

Polaroid Corporation
2020 Swift Drive
Oak Brook 60521
Telephone: (312) 654-5200

Massachusetts

Polaroid Corporation
Telephone:
Toll free 800-225-1618

New Jersey

Polaroid Corporation
P.O. Box 607
W-95 Century Road
Paramus 07652
Telephone: (201) 265-6900

Texas

Polaroid Corporation
1945 Walnut Hill Lane
Irving 75062
Telephone: (214) 258-8100

Australia

Polaroid Australia Pty. Ltd.
Eden Park Estate
31 Waterloo Road
North Ryde, N.S.W. 2113
Tel: (02) 887-2333

Mailing address:
P.O. Box 163
North Ryde, N.S.W. 2113

Belgique/België

Polaroid (Belgium) S.A.-N.V.
Rue Colonel Bourg 113
Kolonel Bourgstraat 113
1140 Bruxelles-Brussel
Tel: 02-736.10.00

Brasil

Polaroid do Brasil Ltda.
Rua Almirante Marques Leão 408
São Paulo 01330, S.P.
Tel: 285-6411

Endereço postal:
Caixa Postal 2908
São Paulo 01000

Canada

Polaroid Canada, Inc.
350 Carlingview Drive
Rexdale, Ontario M9W 5G6
Tel: (416) 675-3680

Danmark

Polaroid A.S.
Blokken 75
3460 Birkerød
Tel: (02) 81 75 00

Deutschland

Polaroid GmbH
Sprenölinger Landstrasse 109
6050 Offenbach
Tel: 069-8404-1

España

Polaroid (España) S.A.
Nuñez de Balboa, 56
Madrid 1
Tel: (1) 435-2509

France

Polaroid (France) S.A.
4, rue J.P. Timbaud
B.P. 47
78391 Bois d'Arcy Cedex
Tel: (3) 460 61 66

Great Britain

Polaroid (U.K.), Ltd.
Ashley Road
St. Albans
Hertfordshire AL 1 5PR
Tel: St. Albans (0727) 59191
Freefone 2122

Hong Kong

Polaroid (Far East) Ltd.
Room 3203-3208, 32nd Floor
Windsor House
311 Gloucester Road
Causeway Bay
Tel: (5) 7951725

Italia

Polaroid (Italia) S.p.A.
Via Piave 11
21051-Arcisate (Varese)
Tel: (0332) 47 00 31

Japan

Nippon Polaroid K.K.
Mori Bldg, No. 30
3-2-2 Toranomon
Minato-ku
Tokyo (105)
Tel: (03) 434-5201

Mexico

Michelmex S.A.*
Apartado Postal #6-952
Mexico 6 D.F.
Tel: 5761914

Nederland

Polaroid Nederland
Zonnebaan 45
3606 CH Maarssenbroek
Klantenservice: 030-44 64 83

Reparaties:

Polaroid (Europa) B.V.
Markt 24
7511 GB Enschede

New Zealand

Polaroid New Zealand Ltd.
Augustus House
15 Augustus Terrace
Parnell, Auckland 1
Tel: 771-682

Mailing address:
P.O. Box 37-046
Parnell
Auckland 1

Norge

Polaroid (Norge) A/S
Industriveien 8B
Postboks 80
1473 Skårer
Tel: (02) 70 47 10

Österreich

Polaroid Ges.m.b.H.
Postfach 66
Eitnergasse 13
1233 Wien
Tel: (0222) 86 43 46

Panama

Polaroid Interamerican, S.A.
P.O. Box 2167
Colon Free Zone
Tel: 45-1722

Puerto Rico

Polaroid Caribbean Corporation
Edificio Centro de Seguros
Ponce de Leon 701, Miramar
Santurce 00904
Tel: (809) 725-6240

Schweiz/Suisse/Svizzera

Polaroid A.G.
Hardturmstrasse 175
8037 Zürich
Tel: (01) 44-72-72

Sverige

Polaroid AB
Ekholmsvägen 34
Box 204
127 24 Skärholmen
Tel: 08/7 10 08 50

*Authorized Service Center

In addition to the Service Centers listed here, there are approved Service Centers within the United States as well as in many other countries. To locate the one closest to you, contact the nearest Polaroid Office, above.

"Polaroid" and "Polacolor" are trademarks of Polaroid Corporation, Cambridge, Massachusetts, U.S.A. "Polaroid" ®

